

EXCELLENCE IN SPRAYING SOLUTIONS

Always at Your Service - AED

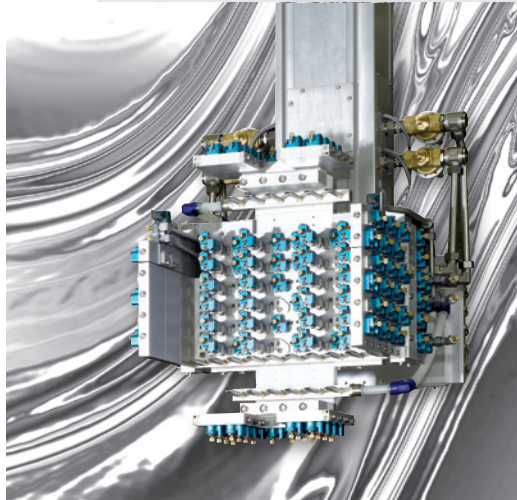

DELTASPEED

State of the Art
Minimum Quantity Spraying

www.aed-automation.com

AED AUTOMATION
Excellence in Spraying Solutions

EXPERIENCE

Since 1973 AED Automation - formerly known as Acheson - is an innovative leader in spraying automation for casting and forging industries. Over the years several generations of spraying automation technology were introduced to the market. Using Acheson technology has improved many processes of numerous customers

1999 the Deltacast® Liquid Powder™ system was introduced. This revolutionary technology was another step ahead in foundry spraying technology. The technology follows the rules of minimum quantity media use. Liquid Powder systems have proven their performance in many customer processes.

2011 AED introduced a new technology - based on proven Flextool technology, following the new trend for oil spraying in casting.

DELTASPEED

A Perfect Combination of Precision and Speed for Minimum Quantity Spraying of Release Agents

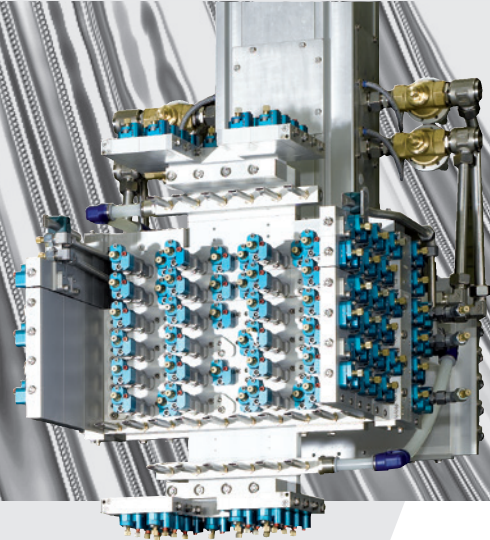

The DELTASPEED technology is a special upgrade for our Flextool™ spraying tools. A combination of Flextool™ modules plus the DELTASPEED kit is allowing the application of extra low quantities of oil.

The installation of the DELTASPEED system can be based on a standard DAG® 1000 MCT linear sprayer or a DAG® 3000 FLT Robospray system

The complete DELTASPEED technology is composed of:

- 1** = DELTASPEED nozzles on Flextool base
- 2** = Connector box for lube and energy
- 3** = DELTASPEED control module
- 4** = DELTASPEED supply unit

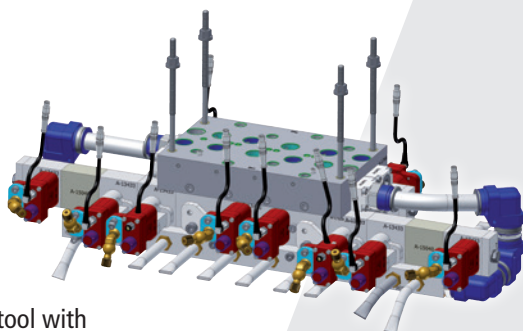

Flextool with DELTASPEED Layout

Flextool FLT 8 Die Geometry

MCT with DELTASPEED Add on Kid

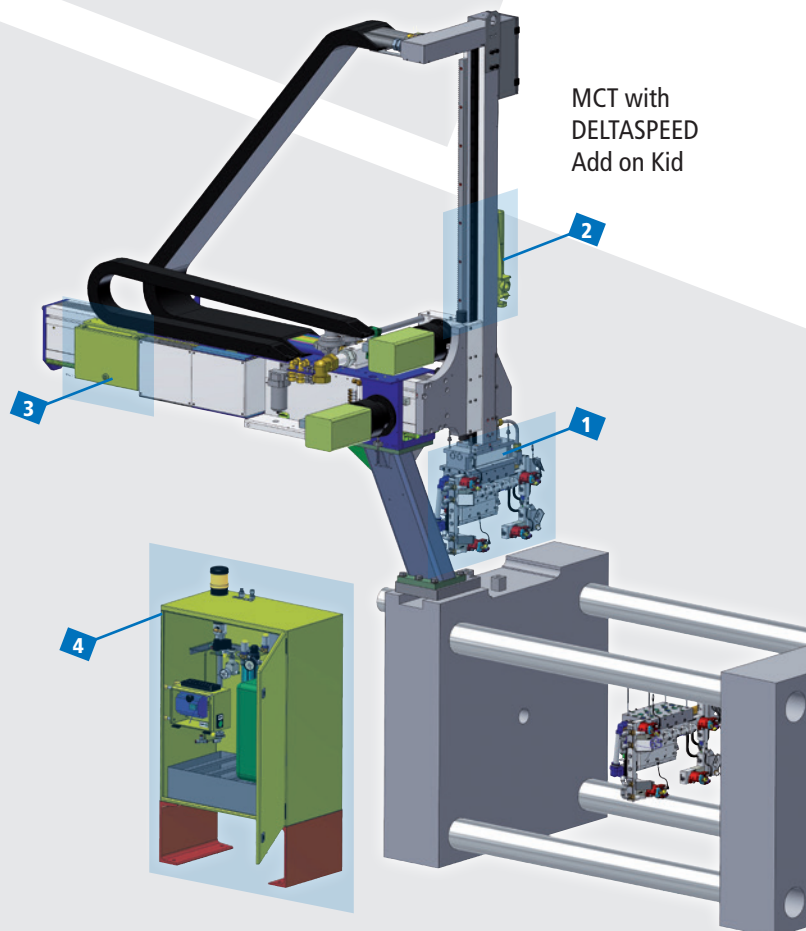

SOME PERFORMANCE FIGURES

- Total spray volume per DELTASPEED nozzle = 0,8 or 1,8 ml
- Flow rate per DELTASPEED nozzle = 0,073 to 0,164 ml/s
- Maximum spray time = 11 sec
- 2 to 5 ml per m² are required to form a reliable coating on the die surface



EXCELLENCE IN SPRAYING SOLUTIONS

FEATURES

- Various setups are possible
- Fully integrated system - turn-key solution
- Upgrade of existing equipment is feasible in most cases
- Robots or 2-axis linear reciprocators can be used
- Static and dynamic spray application is feasible
- Customized spraying tools for shortest cycle times
- Low(er) number of nozzles - easy setup and maintenance
- Lower spraying time even at "big" dies
- Combinable with external die cooling - "mixed" applications
- AED process know how and services for installation, set-up and process optimization

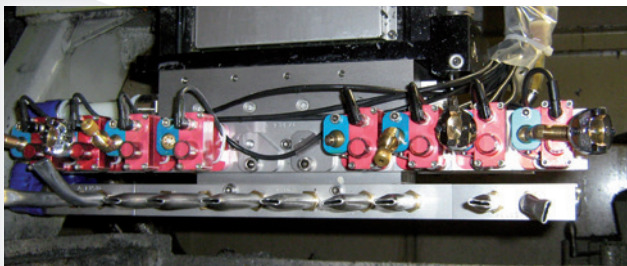

* Rem.: Arguments are valid for high quality lubricants with 100% active content (oils) or highly concentrated emulsions

ADVANTAGES

- ◆ **Lubricant***
 - Excellent wetting properties
 - High wetting temperature (up to 500 °C)
 - Absolutely stable 100% concentrates
 - No or less contamination of waste water with lubricant
 - Significantly less lubricant necessary
 - No risk of bacterial contamination
- ◆ **Die and Casting**
 - Excellent release properties
 - Very clean surfaces
 - Min. porosity of castings
 - No corrosion
 - Separation of cooling and lubrication (hot spot cooling possible)
 - Increased die life
- ◆ **Spraying Process**
 - Emissions minimized
 - No "Black Hole" effects
 - Variable tool set-up for perfect surface coverage
 - Very short spraying times in case there is no spray cooling needed.
 - Well suited for bigger dies (e.g. for structural parts)
 - Modular setup allowing step by step technology change

AUTOMATION AND INTEGRATION

AED is spraying automation - but we can do more. When it comes to line automation, AED can also supply and integrate equipment for various automation functions - complete systems from one source.

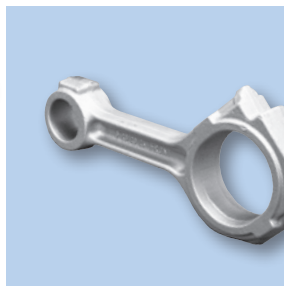
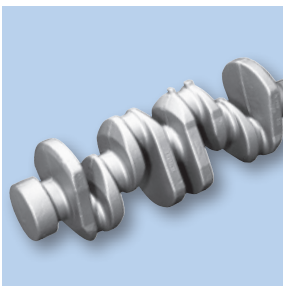
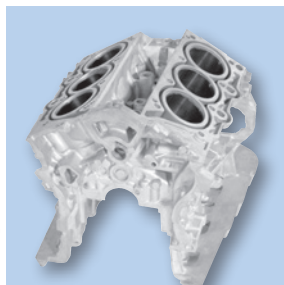
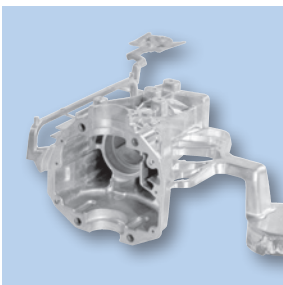
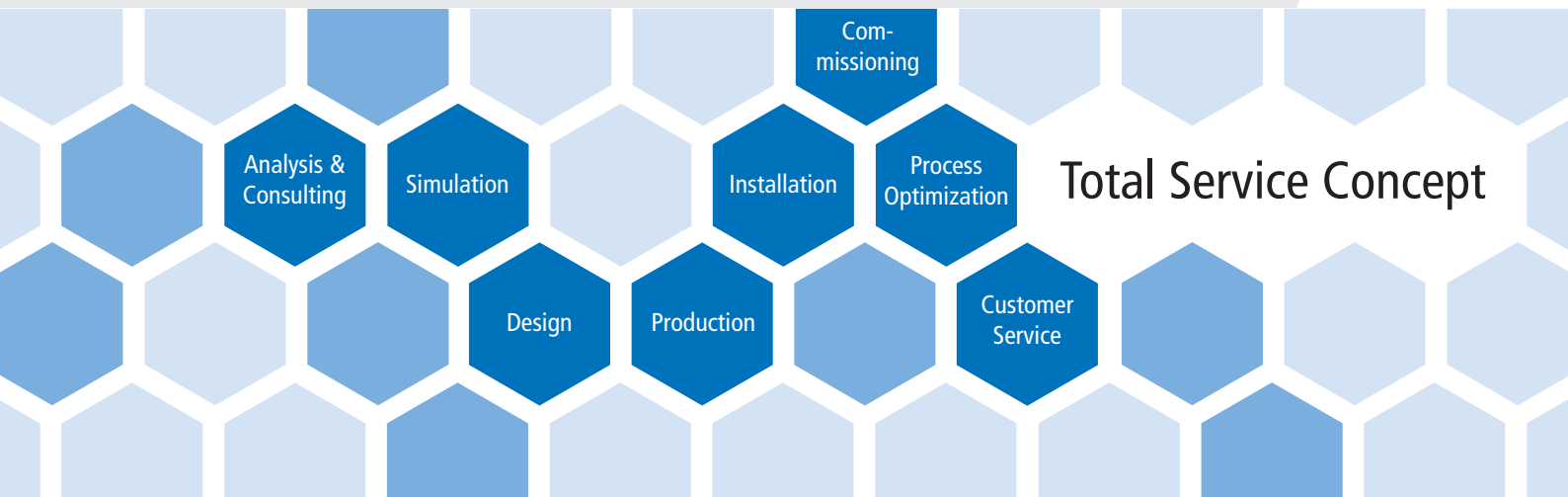

Always at Your Service - AED

AED Automation GmbH
Lerchenbergstraße 23
D-89160 Dornstadt
Germany

fon +49 (0) 7348 2001-0
fax +49 (0) 7348 2001-19
info@aed-automation.com

© 2013 AED Automation GmbH - All Rights Reserved
Deltacast®, Flextool™, DAG®, are registered trademarks of AED Automation GmbH
Liquid Powder™ is a registered trademark of Henkel AG & Co KGaA

www.aed-automation.com

AED AUTOMATION
Excellence in Spraying Solutions